



**ELECTROSWITCH**  
ELECTRONIC PRODUCTS  
UNIT OF ELECTRO SWITCH CORP.

## IP67 Sealed Thumb Switches

Highest quality for the most demanding applications

# TS Series



## Robust Design

## Environmentally Sealed

## Compact Size



Electroswitch  
Phone: 888-768-2797  
[sales@electro-nc.com](mailto:sales@electro-nc.com)

# IP67 Sealed Thumb Switches

Highest quality for the most demanding applications



Catalog No.	Poles	Action	Actuator	Terminal	Terminal Plating	Actuator Color
TS121SZQ2	1	on-off-on	Standard	Solder	Silver	Black
TS123SZQ2	1	on-none-on	Standard	Solder	Silver	Black
TS126SZQ2	1	on-none-mom	Standard	Solder	Silver	Black
TS127SZQ2	1	mom-off-mom	Standard	Solder	Silver	Black
TS131SZQ2	1	on-off-mom	Standard	Solder	Silver	Black

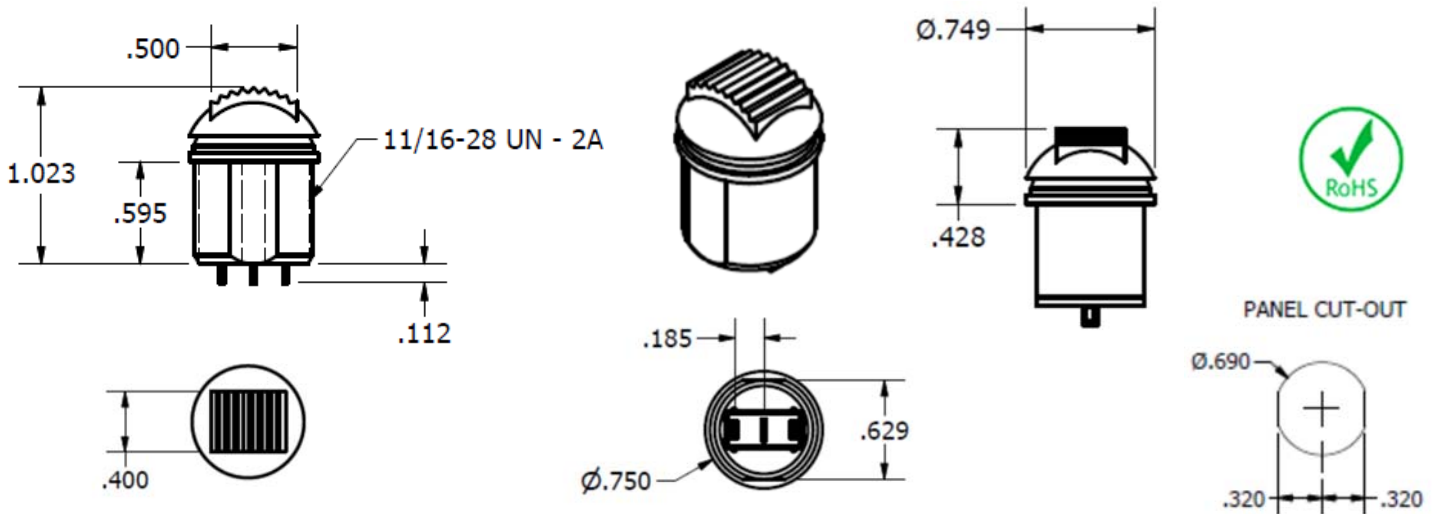

## SPECIFICATIONS:

**Contact Ratings** 6 amp at 125 VAC, 3 amp @ 250 VAC

**Life Under Load** — 60,000 make-and-break cycles — resistive load only.

**Mechanical Life**— 60,000+ cycles

**Initial Contact Resistance** — 10 milliohms maximum 3 VDC, 100 ma.

**Insulation Resistance** — 1,000 megohms, min.

**Dielectric Strength** — 1,000 volts rms at sea level.

**Operating Temperature** — -30 degrees C to 85 degrees C.